



BRICK 'HEADZ

40316

ToysRUs

 [LEGO.com/brickheadz](https://www.lego.com/brickheadz)



GEOFFREY

57





1



2

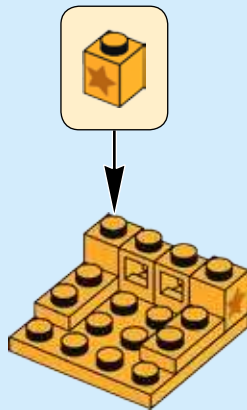

3



2x

3

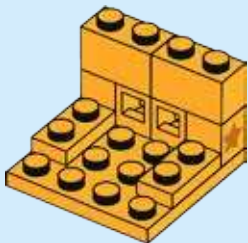

4



1x



2x



2x

4

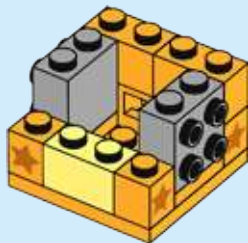



5

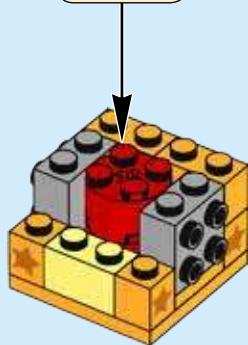



1x



2x

6

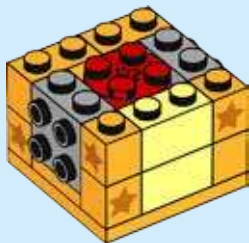
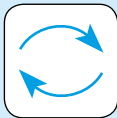

6



4x

7

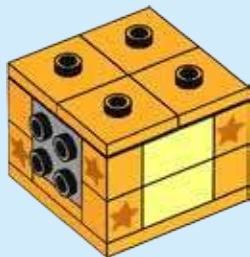



8

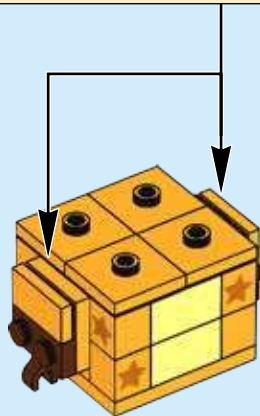
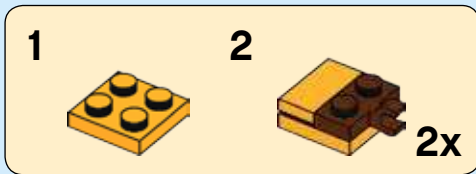



1x



1x

9



8



4x

10





4x

11



1x

12

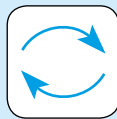



2x



4x

13

1



2

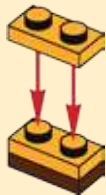

2x

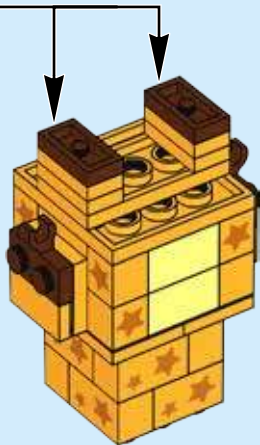



14



15

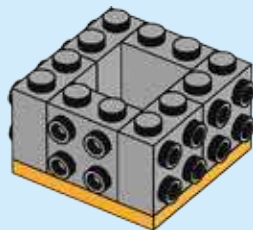



16

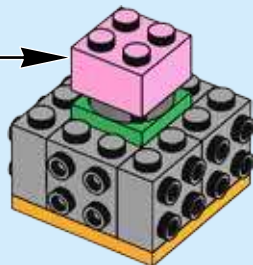
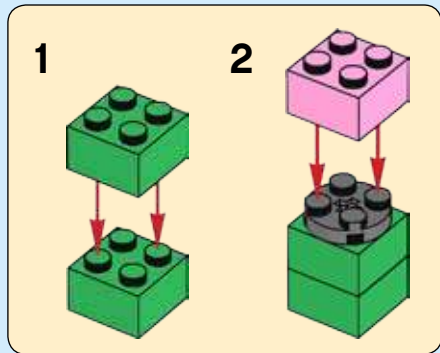



6x

17



1x

18

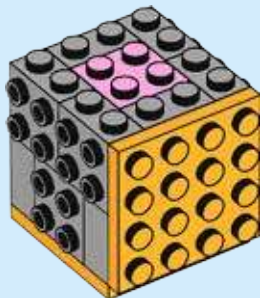



1x



1x



2x

19



14



1x

20

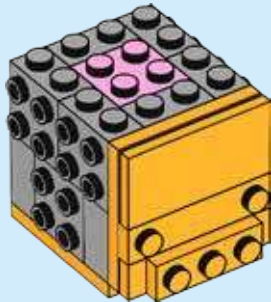

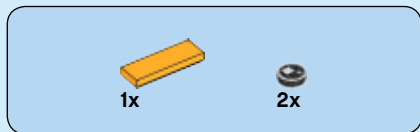

21

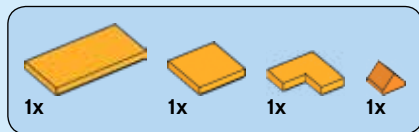
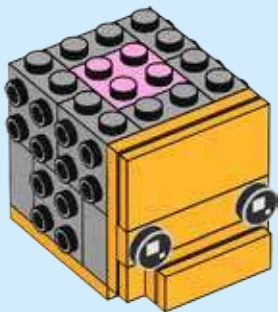

22



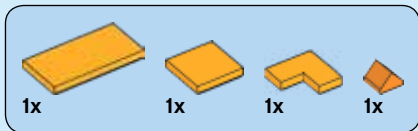

23

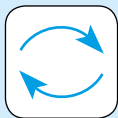

24

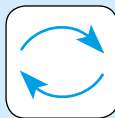

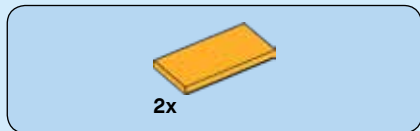

25

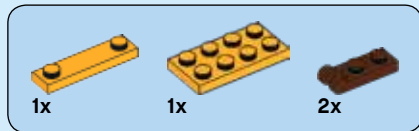

26

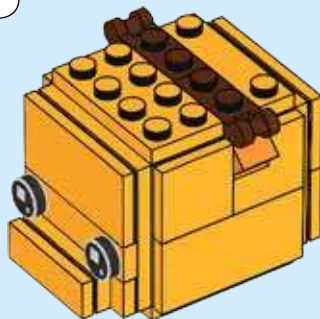
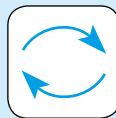



1x

27





1x

28



1x

29

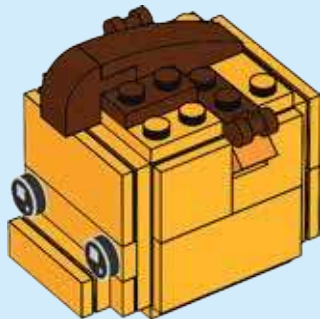



1x



1x

30

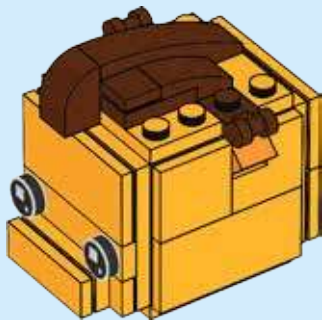

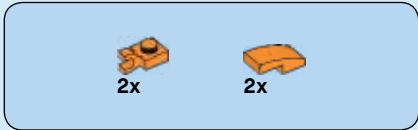

31

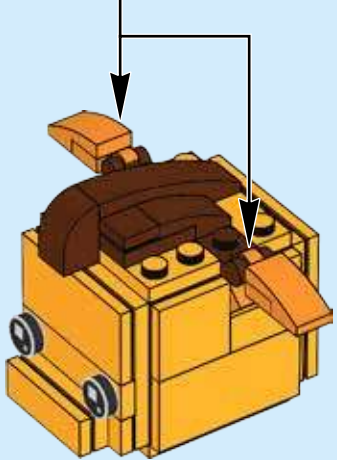
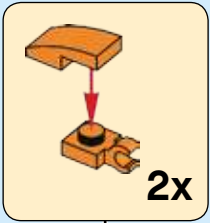



32

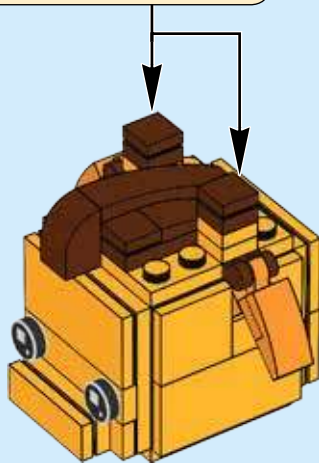
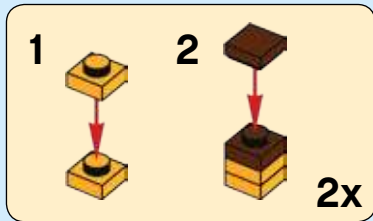

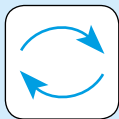

33

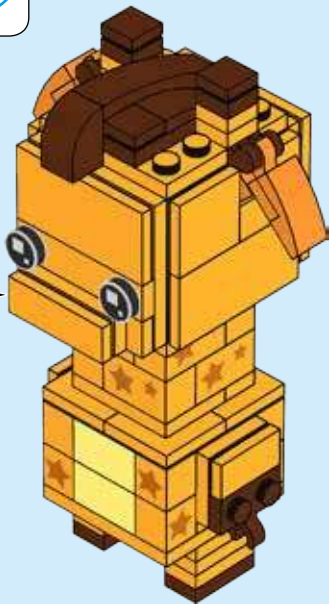

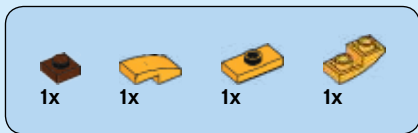

34

1



2



3

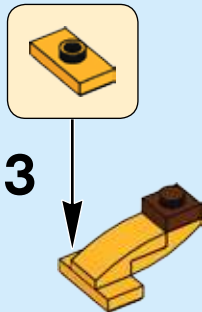

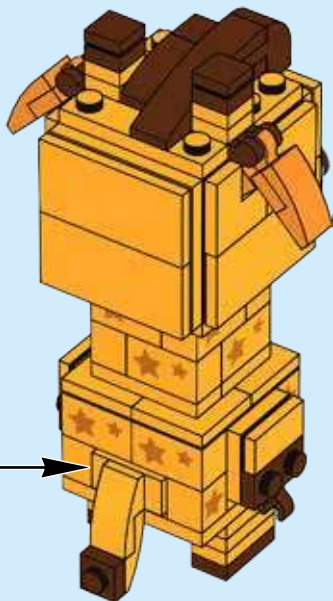
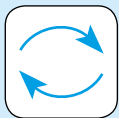

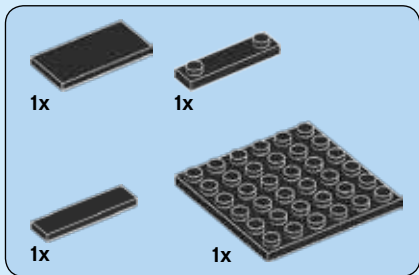

35

1

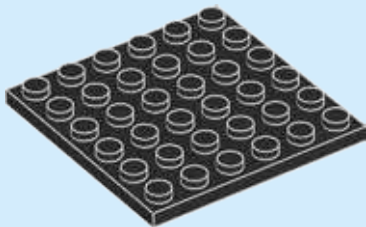

26

2

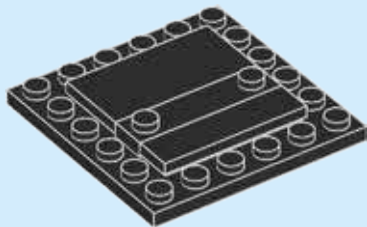

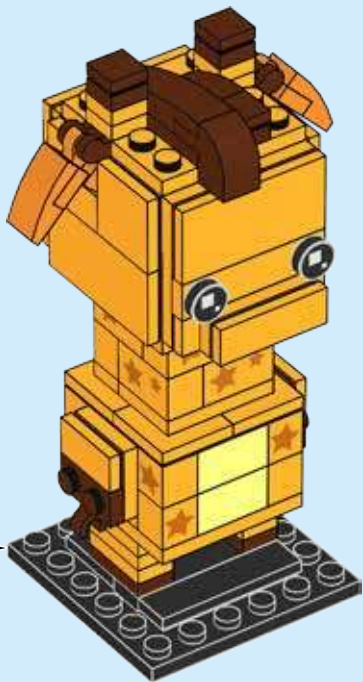
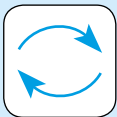



14x
6123809



1x
4211042



1x
4550359



2x
300328



2x
614321



2x
6022083



1x
6178627



1x
243126



1x
4599499



1x
4560182



1x
395826



1x
6045941



3x
4221744



3x
4211288



1x
6069984



2x
4211150



2x
6185998



1x
6035547



1x
4216695



2x
6102975



2x
6223631



2x
4593773



2x
6055069



4x
6073040



6x
6236430



2x
6186006



6x
6028736



3x
6122504



2x
4622062



1x
6099728



10x
6236441



1x
6145215



2x
6020147



4x
6193972



2x
6003033



2x
6099717



1x
6099725



2x
6073042



1x
6097503



2x
6022014



5x
4621543



2x
6097511



4x
6093272



Customer Service

Kundenservice

Service Consommateurs

Servicio Al Consumidor

LEGO.com/service or dial



00800 5346 5555 :



1-800-422-5346 :



LEGO and the LEGO logo are trademarks of the/son des marques de commerce du/son marcas registradas de LEGO Group.
©2018 The LEGO Group. 6242059